

PLATO[®]

Quality Tools for Electronic Assembly and Repair

Product Catalog & Application Guide

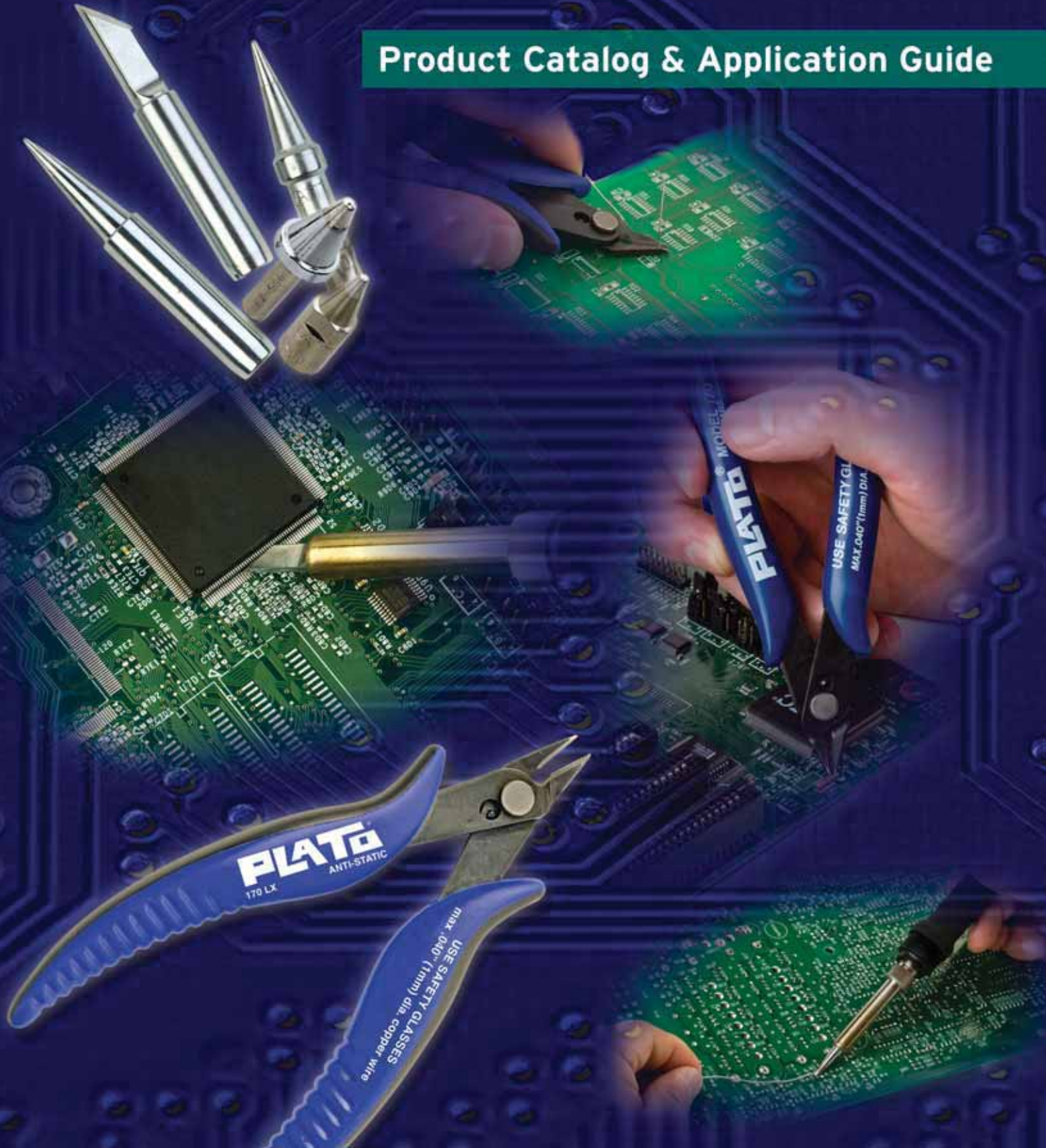



Quality Tools for Electronic
Assembly and Repair



Plato Tips Reduce Production Costs

- Longer life decreases tip consumption
- Rapid heat recovery increases productivity



See page 9 for more information.

All Plato branded products are RoHS compliant. In addition, Plato soldering tips have been proven to withstand harsh lead-free soldering conditions and enhance your productivity.

The European and Chinese RoHS (Restriction of Hazardous Substances) regulations are forcing the electronics industry to transition to lead-free soldering.

The requirement for lead-free soldering requires operators to increase the temperature of their soldering station and to use more active fluxes. Plato soldering tips are constructed with durable metals to resist erosion from high-tin content solders and active fluxes. Using Plato soldering tips

RoHS Compliant 



will actually increase operator productivity. Turn to page 9 for more details on the advantages of Plato soldering tips.

Full RoHS documentation is available at www.platoproducts.com.

While there may be slight differences between some of the part numbers cross-referenced in this catalog, we believe each Plato part number is functionally comparable to the corresponding competitive part number listed. Make sure you are ordering from Plato's current catalog. Plato's specifications, tolerances, products and terms of sale may be changed from time to time. This catalog supersedes any prior Plato catalogs concerning the products described herein, and, in turn will be superseded by any subsequent Plato catalog covering these products. This catalog is copyrighted material of Techspray. Copyright © 2007 by Techspray.

We acknowledge the following trademarks: A.P.E.[®] is a registered trademark of Automated Production Equipment, Inc.; American Beauty[®] is a trademark of Assembly Technologies International, Inc.; Edsyn[®] is a registered trademark of Edsyn[®]; Ersa[®] is a registered trademark of Ersa. Esico[®] is a trademark of Electronic Soldering Iron Co.; Hakko[®] is a registered trademark of Hakko Metal Industries, Ltd.; Loner[®] is a registered trademark of Edsyn[®]; Metcal[®] is a registered trademark of O.K.[®] Industries; Pace[®] is a registered trademark of Pace, Inc.; Hexacon[®] Select-O-Trac[®] and Therm-O-Trac[®] are registered trademarks of Hexacon Electric Co.; Weller[®] is a registered trademark of Cooper Industries, Inc.;

Ungar[®] is a registered trademark of Ungar[®]. Health Advisory Lead, a component of most solders, is known to the State of California to cause cancer and birth defects. To minimize the risk of breathing or otherwise ingesting hazardous materials, the soldering workstation area should be kept clean of solder and chemical residues and adequately ventilated. Fumes generated during soldering may also be removed by fume removal equipment. Additionally, operators should wash their hands prior to eating and should routinely wash their work clothing.

FLUX AND LIQUID DISPENSERS

Plato® flux and liquid dispensers come in several shapes and sizes to work in a wide variety of soldering applications. Needle bottles are ideal for precisely controlled flux applications. Brush bottles are a great way to aggressively but safely clean flux residues and other contaminants from PCB's.

Needle Flux Dispensers

- Dispense precise amounts of liquid without dripping, spilling, or waste
- Unique, no leak design!
- Meets ANSI (J-STD-001B)

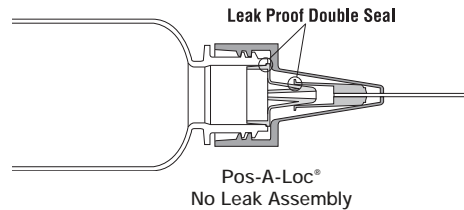

Product	Capillary ID	Recommended Flux Type	Capacity
FD-21	.010" (.25mm)	No-Clean and Water Soluble	2 oz.
FD-2	.020" (.50mm)	Rosin	2 oz.
 SF-01	.010" (.25mm)	No-Clean and Water Soluble	2 oz.
 SF-02	.020" (.50mm)	Rosin	2 oz.

Replacement needles available: FDN-010 for .010" (.25 mm); FDN-020 for .020" (.50mm)



Water and Liquid Dispensing Bottles

BC-250 – Polyethylene bottle, screw cap, and dispensing tube with 8 oz. (237ml) capacity. Inexpensive way to wet sponges and dispense liquids at the work bench without waste.

SF-250 – 8 oz. bottle encased in permanently static dissipative plastic that provides electrostatic discharge protection to meet DOD-STD-1686 and MIL-B-81705, Type 2.



Plato's static dissipative bottles are surrounded by permanently static dissipative sleeves that stay out of contact with flux and other liquids. This prevents conductive "hot spots" on the surface of the bottle.

- Protects voltage sensitive devices from static discharge
- Meets ANSI (J-STD-001B)
- Meets the requirements of DOD-STD-1686 for containers
- Physical characteristics comply with MIL-B-81705, Type 2

Brush Scrub Bottles

- Inexpensive and safe method to spot clean PCB assemblies
- Compatible with IPA, Hexane, and Acetone

SB-2N – 2 oz. bottle with nylon bristles that have medium stiffness for general flux removal.

SF-B2HS – 2 oz. bottle with natural horse hair that has soft to medium stiffness. Durable and works well for flux removal and general cleaning. Combination of static dissipative jacket and natural material meets ANSI (J-STD-001B).

SF-B2HH – 2 oz. bottle with natural hog bristles that are medium to stiff and works well for removing difficult, sticky, crusty, or viscous materials. Combination of static dissipative jacket and natural material meets ANSI (J-STD-001B).



TIP CLEANING SPONGES

TIP CLEANING SPONGES

Plato® sponges are manufactured with pure cellulose (a wood derivative) which has the ability to absorb many times its weight in water. Also resistant to abrasion and tearing forces that occur during the tip wiping process.

Cellular structure is designed to expand when wet, and retain water for long periods of time. Meets ANSI (J-STD-001B) for low sulphur content and fine porosity.

- Extend Tip Life
- Remove Surface Oxides
- Remove Excess Solder

NOTICE: SYNTHETIC sponges are not recommended for use as tip cleaning sponges. Many cheap household type sponges are manufactured with man-made fibers and materials. These sponges contain colorings, sizings, plasticizers, stiffeners, and other contaminants which will promote detinning and shorter tip life.

Use only Plato pure cellulose sponges to aid in keeping your solder tips clean and to extend tip life.

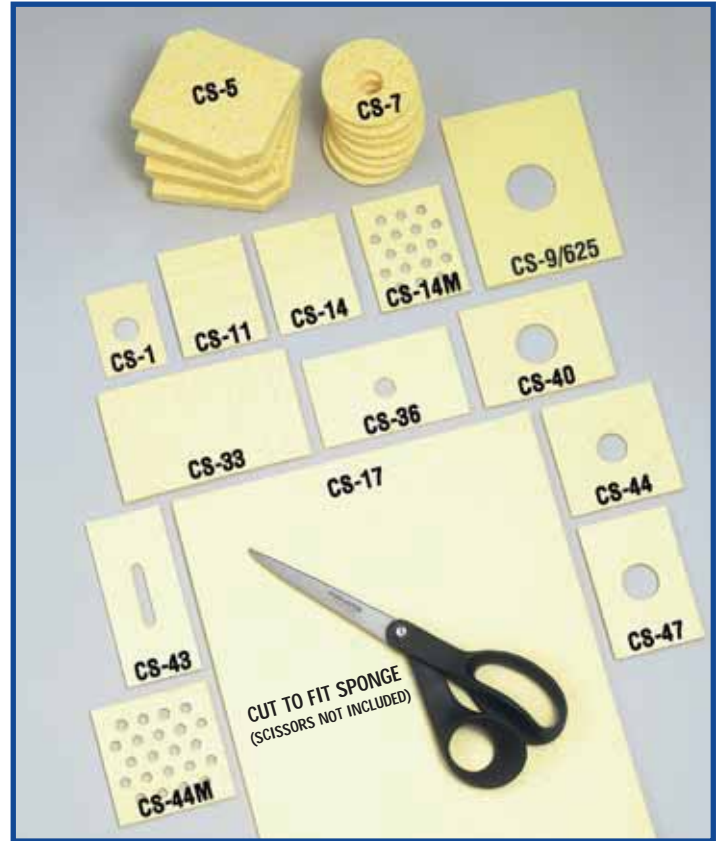

YOUR SOURCE FOR SOLDERING STATION SPONGES

Plato® Sponges	Original Manufacturer's No.	Dimensions	
		Inches	mm
CS-1	Weller® SP-60	1.5" x 2.12"	38 x 54
CS-5	American Beauty® 480S (Shipped full size, 4/pack)	2.63" x 3.2"	67 x 81
CS-7	Plato® TW-555 or TWH-444 (Shipped full size, 7/pack)	2.25" dia.	57 dia.
CS-9/625	Hexacon® 8101, 8101C, 8121 or 8121C, .625" thickness	3.5" x 4.5"	89 x 114
CS-11	Plato® Vac-Kits and Hot Grips	2" x 2.63"	51 x 67
CS-14	Weller® 52241999	2.15" x 2.75"	54.6 x 70
CS-14/625	Same as CS-14 but with .625" thickness	2.15" x 2.75"	54.6 x 70
CS-14M	Same as CS-14 but with multiple holes	2.15" x 2.75"	54.6 x 70
CS-17	Plato® Sponge Sheet (1/pack, you cut to size)	8.5" x 17"	216 x 432
CS-17/625	Same as CS-17 but with .625" thickness	8.5" x 17"	216 x 432
CS-33	Weller® EC-205	2.7" x 4.5"	70 x 114
CS-36	Hexacon® 8141, 8141C	2.25" x 3.5"	57 x 89
CS-36/625	Same as CS-36 but with .625" thickness	2.25" x 3.5"	57 x 89
CS-40	Edsyn® Loner® RS-199	2.5" x 3.25"	64 x 83
CS-43	Hakko® 926-029B	1.75" x 4.25"	45 x 102
CS-44	Hakko® 609-029,A-1042, Weller® TC-205, Ungar® 9904	2.7" x 2.7"	69 x 69
CS-44/625	Same as CS-44 but with .625" thickness	2.7" x 2.7"	69 x 69
CS-44M	Same as CS-44 but with multiple holes	2.7" x 2.7"	69 x 69
CS-47	Metcal® STSS-YS3, Ungar® 455, UTC234	2.1" x 3.2"	53 x 81
CS-47/625	Same as CS-47 but with .625" thickness	2.1" x 3.2"	53 x 81

Unless otherwise noted sponge thickness when wet is one inch.

EXTEND THE LIFE OF YOUR SOLDERING AND DESOLDERING TIPS

TT-95

LEAD-FREE TIP TINNER/CLEANER

Plato's Tip-Tin provides fast, efficient cleaning and re-tinning of highly oxidized soldering iron tips safely and efficiently. This thermally-stable compound is lead-free, ESD, and environmentally safe.

A well-tinned soldering tip improves operator performance and satisfaction. Just wipe the oxidized soldering tip at normal soldering temperature into the tip tinner for a few seconds until the bright tinning surrounds the working end of the tip. Wipe excess residue on a wet cellulose sponge.

- Extends Life of Tip
- Lead Free
- Easy to Use

RoHS Compliant 
 "Always was...always will be"



Before



After

AB-3

TIP POLISHING BAR

Plato® Polishing Bar restores detinned tips for additional service by grinding off baked on oxidation. Save money on soldering iron tips by extending their lives.



01-5000

DESOLDERING TIP CLEANING TOOL

This handy maintenance tool is used to remove solder and flux build-up from inside desoldering tips and solder collector paths.

Select the proper diameter rod to push out any unwanted loose particles or solder. Proper daily maintenance of desoldering equipment minimizes tip clogging and improves performance.

May be used on all popular desoldering equipment such as Pace®, Weller®, Air-Vac®, APE®, Hakko®, and many others. Contains various tip cleaning rods from .020" (.5mm) to .065" (1.65mm) diameter.









TECHSPRAY® DESOLDERING BRAID

Desoldering braid (wick) is pre-fluxed copper braid that is used to remove solder, which allows components to be replaced and excess solder to be removed.



How To Order: Specify "Part Number" and "Length." For example: 1808-5F for 5 feet of #1 white desoldering braid.

	#1 White 	#2 Yellow 	#3 Green 	#4 Blue 	#5 Brown 
	.035" (0.9mm)	.055" (1.4mm)	.075" (1.9mm)	.098" (2.5mm)	.130" (3.3mm)
	Pro-Wick® Rosin For the fastest wicking action, rosin flux coated braid is ideal for high volume PCP production/repair environments.				
Size/Color	1808	1809	1810	1811	1812
Length	5', 10', 100'	5', 10', 25'	5', 10', 25', 100'	5', 10', 25', 100'	5', 10'
	No-Clean Wick The cleanest No-Clean braid in the industry. The proprietary flux formula is specially designed to avoid catastrophic and latent PCB failures caused by ionic flux residue.				
Size/Color	1820	1821	1822	1823	1824
Length	5', 10', 25', 50'	5', 10', 25', 50'	5', 10', 50', 100'	5', 10', 25', 100'	5', 25'

More options available at www.techspray.com

TIP MAINTENANCE

SOLDERING TIP MAINTENANCE AND USAGE GUIDE

Extend the Life of Your Soldering Tip

Lead-free soldering places additional demands on soldering tips. Elevated temperatures, higher tin content solders, and aggressive fluxes attack the metals and reduce the life of the tip.

Solutions for longer tip life:

- Use a high quality Plato solder tip.
- Plato solder tips have a longer life and faster heat recovery than the tips of solder station manufacturers.
- Solder at the lowest possible temperature. Maintain a temperature of 800°F (427°C) or less whenever possible.
- Keep the working end of the tip covered with solder during use and during idling periods.
- Avoid rubbing tip on metals to be joined.
- Turn stations off while not in use.
- Use the three step tip maintenance guide below to get the most life out of each tip.



Extend Soldering Tip Life:

Proper maintenance of soldering tips greatly increases the life of the tip.

STEP 1: Basic tip care with sponge

Consistently wiping off your soldering tip on a damp Plato cellulose sponge is the most important thing you can do to maximize tip life.



STEP 2: Cleaning with Tip Tinner

Plato Lead-Free Tip Tinner aggressively removes light oxidation that builds up over time.



STEP 3: Polish off oxidation

Heavy oxidation can be removed by wiping the cool tip on the Plato Polishing Bar.

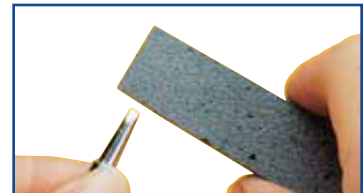

Right — solder tip is approximately the same size as joint to be soldered, allowing maximum contact.



Wrong — solder tip is too small to transfer adequate heat to the solder joint.

Choosing the Right Soldering Tip

Solder tip shapes should be chosen to allow the maximum wetted contact of the tip point with the metals to be soldered.

1. Select the tip shape which offers the maximum contact between the tip and the metals to be joined.
2. Select the shortest tip which will provide satisfactory access.
3. Maintain the largest cross-sectional area (diameter) of the tip shape (minimize the use of tapered and turned down tips).

In summary, select the tip with the largest point face, shortest length and largest diameter, allowing comfortable access to the work.

YOUR ONE SOURCE FOR SOLDERING TIPS

Lead-Free/RoHS Process Compliant



Plato is one of the largest manufacturers of soldering tips in the world, producing tips to fit all of the most popular soldering stations. The long life and fast heat recovery of Plato soldering tips increases user effectiveness and decreases production times. All Plato soldering tips manufactured since January 2004 are tinned with Lead-Free solder.

Long Life:

Using a high quality Plato soldering tip increases soldering speed and decreases the total cost of manufacture. Higher temperatures and high tin content solders, common in lead-free soldering processes, place additional strain on soldering iron tips. The long life of a Plato soldering iron tip reduces tip changes, decreasing the total number of tips used and decreasing production time.

Rapid Heat Recovery:

Plato soldering tips are constructed from highly conductive premium grade copper to transmit heat to the work more quickly than other brands of soldering tips. This quick heat recovery enables more joints to be soldered per minute, thus reducing manufacturing time and costs.

Plato tips are constructed with high-grade copper to enable maximum heat conductivity.

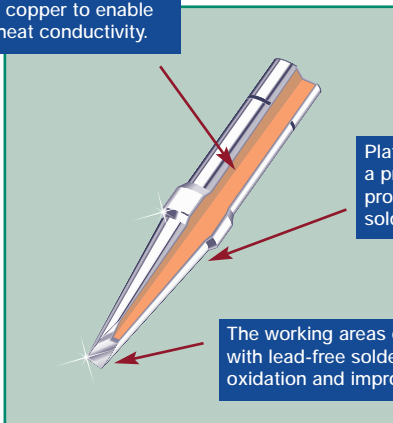

Plato solder tips are coated with a proprietary iron plating which provides long life even in severe soldering conditions.

The working areas of all Plato tips are coated with lead-free solder to protect against oxidation and improve heat transfer.

TIPS

Brand	Page
Weller®	10
Hakko®	14
Pace®	16
Ersa®	18
Edsyn®	19
Hexacon®	19
1/8" Tips	20
3/16" Tips	20
1/4" Tips	21
5/16" Tips	22
3/8" Tips	22
5/8" Tips	23
Quick	23



LONG LIFE TIPS TO REPLACE WELLER'S LT SERIES TIPS

- Longer Life
- Designed for lead-free soldering
- Look for tips with an LF added to the end of the part number

Weller®	Plato® Tip	Tip drawings are actual size.		Weller®	Plato® Tip	Tip drawings are actual size.	
—	MS-4140		.031" (0.8)	LTD LF	NEW! MS-3600 LF		.181" (4.6)
LT1	MS-4120		.010" (0.25)	LTGW	MS-0100		.122" (3.1) / .084" (2.1)
LT1L	MS-4110		.010" (0.25)	LTGW LF	NEW! MS-0100 LF		.122" (3.1) / .084" (2.1)
LT1LX	MS-4101		.010" (0.25)	LTH	MS-3110		.031" (0.8)
LT1S	MS-4100		.063" (1.6)	LTHX	MS-3101		.024" (0.6)
LT4W	MS-5160		.047" (1.2)	LTK	MS-3150		.050" (1.3)
LT4X	MS-3125		0.085 (2.1) / 0.047 (1.2)	LTL	MS-3250		.079" (2.0)
LTA	MS-3200		.063" (1.6)	LTM	MS-3450		.125" (3.2)
LTA LF	NEW! MS-3200 LF		.063" (1.6)	LTS	MS-4130		.018" (0.5)
LTB	MS-3300		.094" (2.4)	LTO LF	NEW! MS-4200 LF		0.039" (0.9)
LTB LF	NEW! MS-3300 LF		.094" (2.4)	LTBB LF	NEW! MS-5300 LF		0.094" (2.4)
LTC	MS-3400		.125" (3.2)	LTCC LF	NEW! MS-5400 LF		0.125" (3.2)
LTC LF	NEW! MS-3400 LF		.125" (3.2)	LTKN LF	NEW! MS-0201-LF		0.162" (4.0) / 0.228" (5.7)
LTD	MS-3600		.181" (4.6)				0.002" (0.05) / 0.06" (1.5)

Be sure to add temperature indicating number to Plato® part number when ordering Plato® C-Tips.

Choose the desired temperature and add it to the end of the Plato part number* (Example C-3039-7)

Desired Temperature	Suffix to Add to Plato Part Number
700°F / 370°C	-7
800°F / 425°C	-8
900°F / 480°C	-9

Weller®	Plato® Tip	Tip drawings are actual size.	Weller®	Plato® Tip	Tip drawings are actual size.
PTA	C-3039		PTP	C-462	
PTB	C-3040		PTR	C-1021	
PTC	C-3036		---	C-4794	
PTD	C-1016		PTS	C-494	
PTE	C-1017		PTT	C-4309	
PTF	C-593		PTAA	C-5139	
PTH	C-3100		PTBB	C-5143	
PTJ	C-3865		PTCC	C-5141	
PTK	C-3043		PTDD	C-5142	
PTL	C-3044				
PTM	C-3102				
PTO	C-4223				



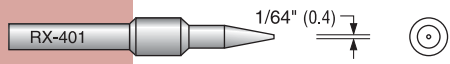

* Indicated temperature ranges are nominal and will vary according to style of tip, condition of iron, manner of use, and other variables. All dimensions are shown before tinning and are subject to manufacturing tolerances.

All points are 1/32" (0.8) thick unless otherwise noted. Tip samples available. () = mm

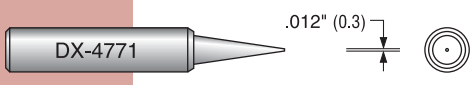

Weller®	Plato® Tip	Tip drawings are actual size.	Weller®	Plato® Tip	Tip drawings are actual size.
ETA	EW-303	1/16"(1.6)	ETO	EW-404	1/32"(0.8)
ETB	EW-305	3/32"(2.4)	ETP	EW-403	1/32"(0.8)
ETC	EW-307	1/8"(3.2)	ETR	EW-101	1/16"(1.6)
ETD	EW-103	3/16"(4.8)		EW-4796	.012"(0.3)
ETE	EW-105	7/32"(5.6)	ETS	EW-402	1/64"(0.4)
ETGW	EW-0574	.195"(5.0) .135"(3.4) SMD Flow Tip	ETT	EW-401	.025"(0.6)
ETH	EW-301	1/32"(0.8)	ETV	EW-511	1/32"(0.8)
ETJ	EW-302	1/32"(0.8)		EW-0602	.020"(0.5) .031"(0.8) SMD
ETK	EW-304	3/64"(1.2)	ETAA	EW-513	1/16"(1.6)
ETL	EW-306	5/64"(2.0)	ETBB	EW-515	3/32"(2.4)
ETM	EW-308	1/8"(3.2)	ETCC	EW-517	1/8"(3.2)

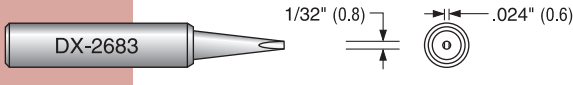





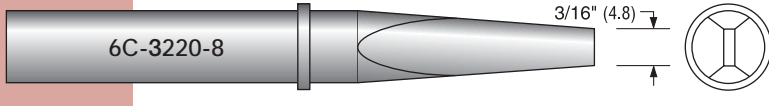



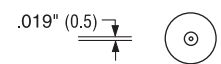
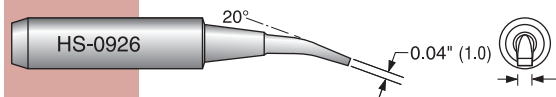
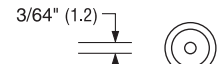
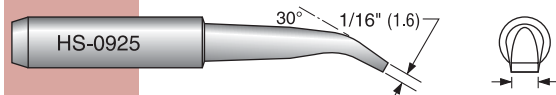
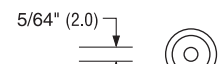
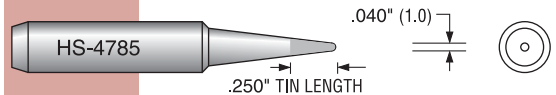
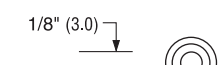
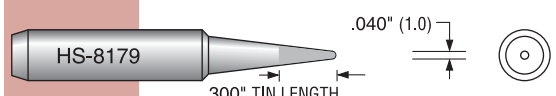
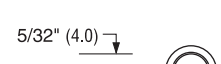

Weller®	Plato® Tip	Tip drawings are actual size.
EPH101		
EPH110		

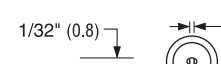
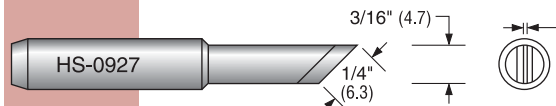
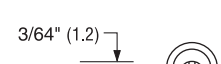
Micro Soldering Pencil • MLR 20 • MPR 30

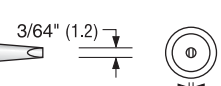
Weller®	Plato® Tip	Tip drawings are actual size.
MPT-1		
MPT-1S		
MPT-H		
		

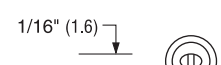
Soldering Iron • W100PG

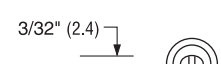
Weller®	Plato® Tip	Tip drawings are actual size.
CT6D8		
CT6F8		

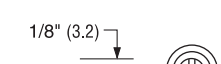
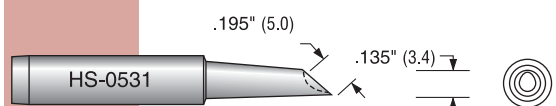
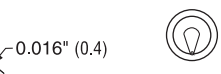
Hakko®	Plato® Tip	Tip drawings are actual size.	Hakko®	Plato® Tip	Tip drawings are actual size.
900M-T-0.5C	HS-5715		900M-T-1.8H	HS-0926	
900M-T-1C	HS-5701		900M-T-H	HS-0925	
900M-T-2C	HS-5702		900M-T-B	HS-4785	
900M-T-3C	HS-5703		900M-T-LB	HS-8179	
900M-T-4C	HS-5875		900M-T-1	HS-4786	
900M-T-3CF	HS-5864		900M-T-K	HS-4787	
900M-T-0.8D	HS-2863		900M-T-S1	HS-0927	
900M-T-1.2D	HS-2796		900M-T-S3	HS-2796	
900M-T-1.2LD	HS-6030		900M-T-S4	HS-1665	
900M-T-1.6D	HS-2751		900M-T-S5	HS-8175	
900M-T-2.4D	HS-2752		SMD Flow Tip	HS-0530	
900M-T-3.2D	HS-2753		SMD Flow Tip	HS-0531	
900M-T-0.2RB	HS-4791				

Hakko®	Plato® Tip	Tip drawings are actual size.	
900L-T-B	HS-4788		
900L-T-2B	HS-4789		
900L-T-2.4D	HS-6027		
900L-T-3.2D	HS-2755		
900L-T-5C	HS-5876		
900L-T-K	HS-0922		
900L-T-S1	HS-1666		

Desoldering Irons • 474 • 475 • 701 • 702B
 Handpieces • 808 • 809

Hakko®	Plato®	(mm)	(mm)	Plato® Premium Grade Tip	Tip drawings are actual size.
		D1	D2		
A-1002	HK-0878	.030" (0.8)	.070" (1.8)	<p>Premium Quality for Long Life Iron plated outside and stainless steel tube insert prevents solder path erosion by solder. Tip samples are available. All dimensions are shown before tinning and are subject to manufacturing tolerances.</p>	
A-1003	HK-0879	.040" (1.0)	.080" (2.0)		
A-1004	HK-0880	.030" (0.8)	.090" (2.3)		
A-1005	HK-0881	.040" (1.0)	.100" (2.5)		
A-1006	HK-0882	.050" (1.3)	.120" (3.0)		
A-1007	HK-0883	.060" (1.5)	.120" (3.0)		

Pace®

Plato® Tip

Tip drawings are actual size.

1121-0335	33-6055	1/16" (1.5)	
1121-0336	33-8142	1/32" (0.8)	
1121-0337	33-6058	1/8" (3.2)	
1121-0357	33-8141	1/64" (0.4)	
1121-0358	33-1658	3/16" (4.8)	
1121-0359	33-1144	1/32" (0.8)	
1121-0360	33-6057	3/32" (2.4)	
1121-0361	33-1146	.020" (0.5)	
1121-0363	33-8143	.020" (0.5)	
1121-0402	SMP-2004	3/16" (4.7)	
1121-0406	33-5894	1/8" (3.2)	
1121-0414	33-6056	1/16" (1.5)	
1121-0490	33-5895	.195" (5.0)	
1121-0499	33-1147	1/16" (1.5)	
1121-0516	33-3981	.015" (0.4)	
1121-0526	33-3982	.015" (0.4)	
1121-0531	33-7106	.187" (4.8)	
1121-0532	33-7107	.125" (3.2)	
1121-0533	33-7103	.062" (1.6)	

Desoldering Tips to Replace Pace Endura Tips

Desoldering Irons SX90, SX-80 and SX-70 with Paper Chamber 3/16" Diameter



Pace®	Plato®	ID	OD	
1121-0625	30-0301	.030"	.080"	NEW!
1121-0624	30-0401	.040"	.090"	
1121-0626	30-0601	.060"	.120"	NEW!
1121-0627	30-0901	.090"	.200"	
1121-0628	30-1003	.030"	.090"	NEW!
1121-0629	30-1004	.040"	.10"	
1121-0630	30-1006	.060"	.120"	NEW!
1121-0681	30-1020	.020"	.070"	
1121-0682	30-1030	.030"	.080"	NEW!
1121-0683	30-1040	.040"	.090"	
1121-0631	30-1060	.060"	.185"	NEW!
1121-0680	30-1200	.020"	.070"	NEW!
1121-0678	30-1300	.030"	.080"	
1121-0679	30-1400	.040"	.090"	NEW!
1121-0690	30-1600	.060"	.110"	

Desoldering Irons SX90, SX-80 and SX-70 with Glass Chamber 3/16" Diameter





Pace®	Plato®	D1 (mm)	D2	
1121-0367	30-0300	.030" (0.8)	.065" (1.7)	 Tip drawing is actual size.
1121-0342	30-0400	.040" (1.0)	.085" (2.2)	
1121-0463	30-040	.040" (1.0)	.085" (2.2)	
---	30-050	.050" (1.3)	.095" (2.4)	
1121-0368	30-0600	.060" (1.5)	.115" (2.9)	
1121-0464	30-060	.060" (1.5)	.115" (2.9)	
1121-0507	30-0900	.090" (2.3)	.190" (4.8)	

Desoldering Irons • Pace® • Air-Vac® • A.P.E.



Pace®	Plato®	L	D1	D2	
Plato® Tips to fit Pace® SX-20, SX-25, SX-25V SODR-X-TRACTORS®					 NOT ACTUAL SIZE.
1121-0480	20-0114	1.00" (25.4)	.030" (0.8)	.060" (1.5)	
---	20-0815	1.00" (25.4)	.036" (0.9)	.065" (1.7)	
1121-0479	20-0110	1.00" (25.4)	.040" (1.0)	.080" (2.0)	
1121-0216	20-0113	1.00" (25.4)	.050" (1.3)	.090" (2.3)	
1121-0217	20-0111	1.00" (25.4)	.060" (1.5)	.100" (2.5)	

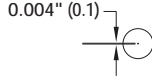

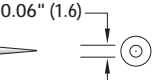

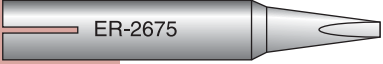
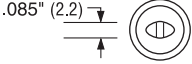
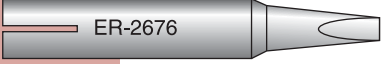
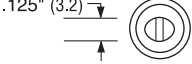
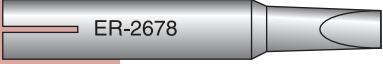
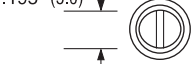

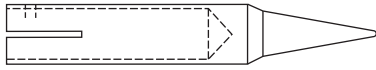
Pace®	Plato®	L	D1	D2	
Plato® Tips to fit Pace® SX-40A, SX-55A, SX-65A, SX-70 SODR-X-TRACTORS® with Plato Adapter 33-0001					 NOT ACTUAL SIZE.
1121-0485	20-025	1.75" (44.5)	.030" (0.8)	.080" (2.0)	
1121-0486	20-040	1.75" (44.5)	.040" (1.0)	.080" (2.0)	
---	20-050	1.75" (44.5)	.050" (1.3)	.090" (2.3)	
1121-0255	20-060	1.75" (44.5)	.060" (1.5)	.100" (2.5)	

Ersa®	Plato® Tip	Tip drawings are actual size.
212BD	 ER-4007	
212SD	 ER-4001	

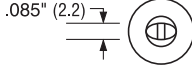
Ersa®	Plato® Tip	Tip drawings are actual size.
602CD	 ER-2675	
602ED	 ER-2676	
602VD	 ER-2678	

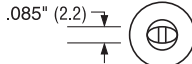
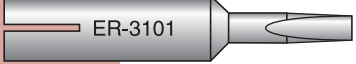
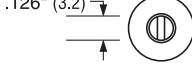

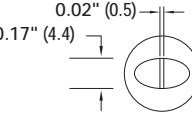
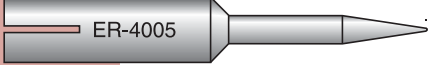
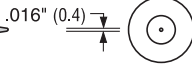
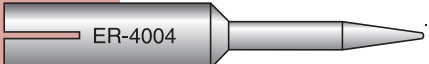
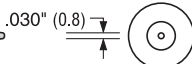

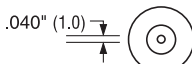





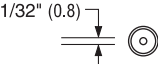

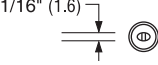



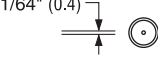

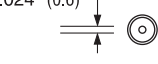

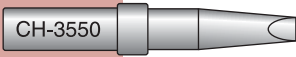
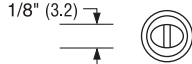
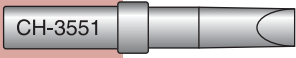
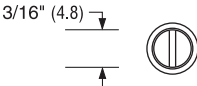

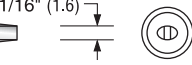
Typical Tip Drawing

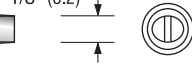
832CD	 ER-3998	
832KD	 ER-3997	
832ED	 ER-3101	
832VD	 ER-3511	
832UD	 ER-4005	
832SD	 ER-4004	
832BD	 ER-4002	

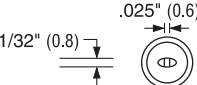

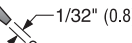

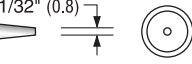
Typical Tip Drawing

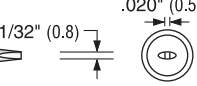
Edsyn®	Plato® Tip	Tip drawings are actual size.
LT374		
LT375		
LT376		
LT383		
LT429		

Hexacon®	Plato® Tip	Tip drawings are actual size.
J101X		
J102X		
J301X		
J302X		
J912X		
J915X		
J917X		
J935X		



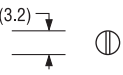

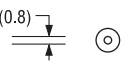



1/8"
TIPS

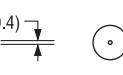

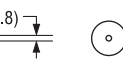

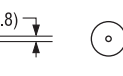

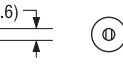
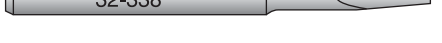
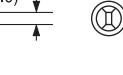























1/8" (3.2mm) Plato® Tips to fit Soldering Irons For
Hexacon® • American Beauty® • Esico® • Pace® • A.P.E.®









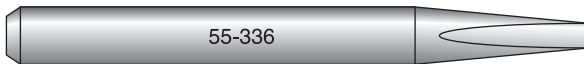

Hexacon®	American Beauty®	Esico®	Plato®	Plato® Tip	Tip drawings are actual size.
HT376	502	210-107 210-114	22-142		
HT222	510	240-102 240-111	22-449		

















3/16"
TIPS



3/16" (4.8mm) Plato® Tips to fit Soldering Irons For
• Hexacon® • American Beauty® • Esico®

Hexacon®	American Beauty®	Esico®	Plato®	Plato® Tip	Tip drawings are actual size.
HT118	630	---	32-402		
HT479	626	342-112 342-119	32-660		
HT281	625	---	33-415		
HT276	604	311-103 311-124	31-150		
HT548	615	322-220 322-146	32-338		
HT207	617	320-109 320-118	33-364		

Hexacon®	American Beauty®	Esico®	Plato®	Plato® Tip	Tip drawings are actual size.
HT513	---	442-153 442-139	42-628		
HT359	716	422-108 422-132	42-355		
HT453	---	---	40-712	 Tinned on flat only	
HT358	714	422-347 422-144	42-347		
HT451	701	412-103 412-131	42-117		
HT417	721	420-106 420-119	44-390		
HT586	---	420-201	44-706		
HT426	---	420-114	44-715		
HT397	720	420-143 420-164	44-386		
HT463	---	413-102 413-134	43-754		
HT313	715	---	44-352		
HT202	738	420-130	44-611		
HT552	---	426-161 426-173	46-626		
HT773	---	426-189	46-912		
HT553* *similar	704	410-140 410-126	44-152		

Hexacon®	Plato®	Plato® Tip	Tip drawings are actual size.
HT556	55-336		$1/8"$ (3.2) 
HT5550	55-321		$3/16"$ (4.8) 
HT506	55-316		$1/4"$ (6.4) 
HT547	55-118		$5/16"$ (8.0) 
	55-133		$5/16"$ (8.0) 

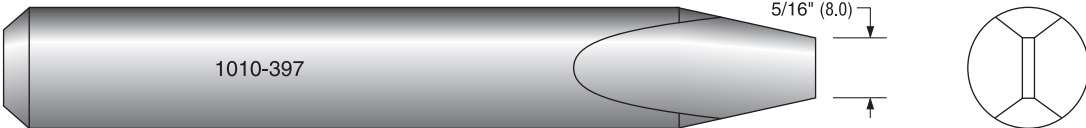
Hexacon®	American Beauty®	Plato® Tip	Tip drawings are actual size.
HT108			$1/16"$ (1.6) 
HT566	43D		$1/16"$ (1.6) 
HT129			$3/16"$ (4.8) 
			$3/16"$ (4.8) 
HT449	823		$1/4"$ (6.4) 
HT470			$5/16"$ (8.0) $3/32"$ (2.4) 
HT151			$3/8"$ (9.5) 
	43C		$3/8"$ (9.5) $11/64"$ (4.4) 

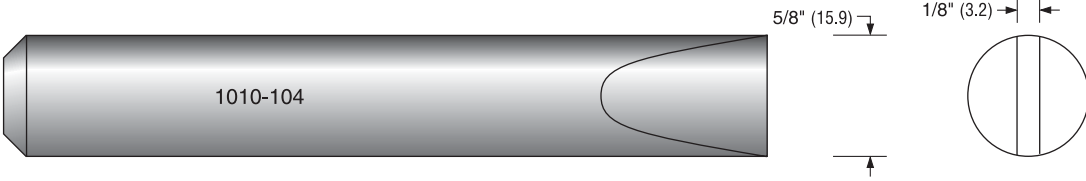
Hexacon®	American Beauty®	Weller®	Plato® Tip	Tip drawings are actual size.
HT256	44D		1010-286	
HT178			1010-397	
HT499	44C		1010-184	
HT891		MTG40	1010-104	

Soldering Stations • 203 • 203H • 204 • 204H

QUICK

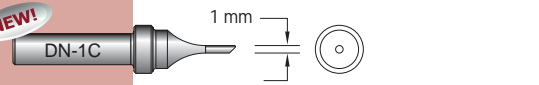
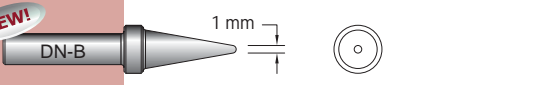
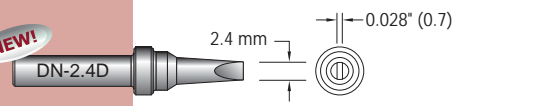
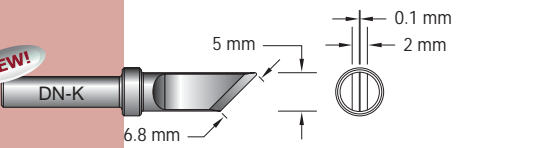
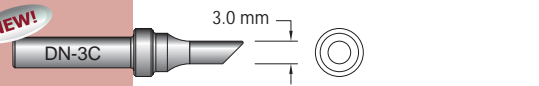
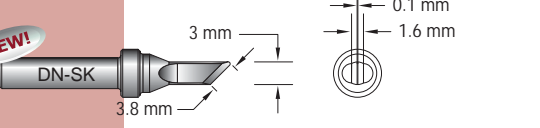
Quick	Plato® Tip	Tip drawings are actual size.	Quick	Plato® Tip	Tip drawings are actual size.
200-1C	NEW! DN-1C		200-B	NEW! DN-B	
200-2.4D	NEW! DN-2.4D		200-K	NEW! DN-K	
200-3C	NEW! DN-3C		200-SK	NEW! DN-SK	

CROSS REFERENCE

A.P.E.®	Plato®	Pg.
1212-0001	22-4927	
1212-0016	22-2931	
1212-0040	20-0110	17
1212-0050	20-0113	17
1212-0060	20-0111	17

1212-0082	20-0111	17
1212-0083	20-0113	17
1212-0084	20-0110	17
1212-0440	1212-0110	
1212-0550	20-0113	17
1212-0660	20-0111	17

Air-Vac	Plato®	Pg.
30	20-0110-HW	
45	20-0110-HW	
46	20-0110-HW	
51	20-0113	17
60	20-0111	17
61	20-0111	17

American Beauty®	Plato®	Pg.
43C	66-704	22
43D	66-201	22
44C	1010-184	23
44D	1010-286	23
502	22-142	20
510	22-449	20
604	31-150	20
615	32-338	20
617	33-364	20
625	33-415	20
626	32-660	20
630	32-402	20
701	42-117	21
704	44-152	21
714	42-347	21
715	44-352	21
716	42-355	21
720	44-386	21
721	44-390	21
738	44-611	21
823	66-300	22

Edsyn®	Plato®	Pg.
LT374	E-4709	19
LT375	E-2621	19
LT376	E-2622	19
LT383	E-4781	19
LT429	E-4710	19

Ersa®	Plato®	Pg.
212BD	ER-4007	18
212SD	ER-4001	18

602CD	ER-2675	18
602ED	ER-2676	18
602VD	ER-2678	18
832BD	ER-4002	18
832CD	ER-3998	18
832ED	ER-3101	18
832KD	ER-3997	18
832SD	ER-4004	18
832UD	ER-4005	18
832VD	ER-3511	18

Esico®	Plato®	Pg.
210-107	22-142	20
210-114	22-142	20
240-102	22-449	20
240-111	22-449	20
311-103	31-150	20
311-124	31-150	20
320-109	33-364	20
320-118	33-364	20
322-146	32-338	20
322-220	32-338	20
342-112	32-660	20
342-119	32-660	20
410-126	44-152	21
410-140	44-152	21
412-103	42-117	21
412-131	42-117	21
413-102	43-754	21
413-134	43-754	21
420-106	44-390	21
420-114	44-715	21
420-119	44-390	21
420-130	44-611	21
420-143	44-386	21
420-164	44-386	21
420-201	44-706	21
422-108	42-355	21
422-132	42-355	21
422-144	42-347	21
422-347	42-347	21
426-161	46-626	21
426-173	46-626	21
426-189	46-912	21
442-139	42-628	21
442-153	42-628	21

Hakko®	Plato®	Pg.
900L-T-2.4D	HS-6027	15
900L-T-2B	HS-4789	15
900L-T-3.2D	HS-2755	15
900L-T-5C	HS-5876	15
900L-T-B	HS-4788	15
900L-T-K	HS-0922	15

900L-T-S1	HS-1666	15
900M-T-0.2RB	HS-4791	14
900M-T-0.5C	HS-5715	14
900M-T-0.8D	HS-2863	14
900M-T-1.2D	HS-2796	14
900M-T-1.2LD	HS-6030	14
900M-T-1.6D	HS-2751	14
900M-T-1.8H	HS-0926	14
900M-T-1C	HS-5701	14
900M-T-2.4D	HS-2752	14
900M-T-2C	HS-5702	14
900M-T-3.2D	HS-2753	14
900M-T-3C	HS-5703	14
900M-T-3CF	HS-5864	14
900M-T-4C	HS-5875	14
900M-T-B	HS-4785	14
900M-T-H	HS-0925	14
900M-T-I	HS-4787	14
900M-T-K	HS-0927	14
900M-T-LB	HS-4786	14
900M-T-S1	HS-2796	14
900M-T-S3	HS-1665	14
900M-T-S4	HS-8175	14
900M-T-S5	HS-8157	14
A-1002	HK-0878	15
A-1003	HK-0879	15
A-1004	HK-0880	15
A-1005	HK-0881	15
A-1006	HK-0882	15
A-1007	HK-0883	15
SMD Flow Tip	HS-0530	14
	HS-0531	14

Hexacon®	Plato®	Pg.
HT108	66-409	22
HT118	32-402	20
HT129	66-367	22
HT151	66-145	22
HT178	1010-397	23
HT202	44-611	21
HT207	33-364	20
HT222	22-449	20
HT256	1010-286	23
HT276	31-150	20
HT281	33-415	20
HT313	44-352	21
HT358	42-347	21
HT359	42-355	21
HT376	22-142	20
HT397	44-386	21
HT417	44-390	21
HT426	44-715	21
HT449	66-300	22
HT451	42-117	21

HT453	40-712	21
HT463	43-754	21
HT470	66-349	22
HT479	32-660	20
HT499	1010-184	23
HT506	55-316	22
HT513	42-628	21
HT547	55-118	22
HT548	32-338	20
HT550	55-321	22
HT552	46-626	21
HT553	44-152	21
HT556	55-336	22
HT566	66-201	22
HT586	44-706	21
HT773	46-912	21
HT891	1010-104	23
J101X	CH-3550	19
J102X	CH-3551	19
J301X	CH-3489	19
J302X	CH-3534	19
J912X	CH-3868	19
J915X	CH-4427	19
J917X	CH-4299	19
J935X	CH-3867	19
Pace®	Plato®	Pg.
1121-0216	20-0113	17
1121-0217	20-0111	17
1121-0255	20-060	17
1121-0335	33-6055	16
1121-0336	33-8142	16
1121-0337	33-6058	16
1121-0342	30-0400	17
1121-0357	33-8141	16
1121-0358	33-1658	16
1121-0359	33-1144	16
1121-0360	33-6057	16
1121-0361	33-1146	16
1121-0363	33-8143	16
1121-0367	30-0300	17
1121-0368	30-0600	17
1121-0402	SMP-2004	16
1121-0406	33-5894	16
1121-0414	33-6056	16
1121-0463	30-040	17
1121-0464	30-060	17
1121-0479	20-0110	17
1121-0480	20-0114	17
1121-0485	20-025	17
1121-0486	20-040	17
1121-0490	33-5895	16
1121-0499	33-1147	16
1121-0507	30-0900	17

1121-0516	33-3981	16
1121-0526	33-3982	16
1121-0531	33-7106	16
1121-0532	33-7107	16
1121-0533	33-7103	16
1121-0624	30-0401	17
1121-0625	30-0301	17
1121-0626	30-0601	17
1121-0627	30-0901	17
1121-0628	30-1003	17
1121-0629	30-1004	17
1121-0630	30-1006	17
1121-0631	30-1060	17
1121-0678	30-1300	17
1121-0679	30-1400	17
1121-0680	30-1200	17
1121-0681	30-1020	17
1121-0682	30-1030	17
1121-0683	30-1040	17
1121-0690	30-1600	17

Quick	Plato®	Pg.
200-1C	DN-1C	23
200-2.4D	DN-2.4D	23
200-3C	DN-3C	23
200-B	DN-B	23
200-K	DN-K	23
200-SK	DN-SK	23

Weller®	Plato®	Pg.
CT6D8	6C-3220-8	13
CT6F8	6C-1083-8	13
EPH101	RX-4762	13
EPH110	RX-401	13
ETA	EW-303	12
ETAA	EW-513	12
ETB	EW-305	12
ETBB	EW-515	12
ETC	EW-307	12
ETCC	EW-517	12
ETD	EW-103	12
ETE	EW-105	12
ETGW	EW-0574	12
ETH	EW-301	12
ETJ	EW-302	12
ETK	EW-304	12
ETL	EW-306	12
ETM	EW-308	12
ETO	EW-404	12
ETP	EW-403	12
ETR	EW-101	12
ETS	EW-402	12
ETT	EW-401	12
ETV	EW-511	12

LT1	MS-4120	10
LT1L	MS-4110	10
LT1LX	MS-4101	10
LT1S	MS-4100	10
LT4W	MS-5160	10
LT4X	MS-3125	10
LTA	MS-3200	10
LTA LF	MS-3200LF	10
LTB	MS-3300	10
LTB LF	MS-3300LF	10
LTBB LF	MS-5300LF	10
LTC	MS-3400	10
LTC LF	MS-3400LF	10
LTCC LF	MS-5400LF	10
LTD	MS-3600	10
LTD LF	MS-3600LF	10
LTGW	MS-0100	10
LTGW LF	MS-0100LF	10
LTH	MS-3110	10
LTHX	MS-3101	10
LTK	MS-3150	10
LTKN LF	MS-0201LF	10
LTL	MS-3250	10
LTM	MS-3450	10
LTO LF	MS-4200LF	10
LTS	MS-4130	10
MPT-1	DX-4771	13
MPT-1S	DX-4814	13
MPT-H	DX-2683	13
MTG40	1010-104	23
PTA*	C-3039	11
PTAA*	C-5139	11
PTB*	C-3040	11
PTBB*	C-5143	11
PTC*	C-3036	11
PTCC*	C-5141	11
PTD*	C-1016	11
PTDD*	C-5142	11
PTE*	C-1017	11
PTF*	C-593	11
PTH*	C-3100	11
PTJ*	C-3865	11
PTK*	C-3043	11
PTL*	C-3044	11
PTM*	C-3102	11
PTO*	C-4223	11
PTP*	C-462	11
PTR*	C-1021	11
PTS*	C-494	11
PTT*	C-4309	11

* A temperature designing number is used by both Plato and Weller, e.g. Weller PTA-7 is equivalent to Plato C-3039-7



ALATO[®]

High Performance Soldering Tips and Tools for Electronics Assembly and Repair



TECHSPRAY[®]



TECHSPRAY
P.O. BOX 949
AMARILLO, TX 79105-0949
PHONE: (806) 372-8523
FAX: (806) 372-8750
TOLL-FREE: (800) 858-4043
email: tsales@techspray.com



ITW CONTAMINATION CONTROL
SKEJBY NORDLANDSVEJ 307
DK-8200 AARHUS N
DENMARK
TEL. +45 87 400 220
FAX. +45 87 400 222
email: info@itw-cc.com